

SCREW AIR COMPRESSOR MICRO CONTROLLER

OPERATION MANUAL

 **Attention**



Please read this manual carefully before operation.



Only Authorized technicians are allowed to install MAM—KY.



Please take into fully consideration of the installation position during the mechanical installation to ensure good vent condition and to minimize the electromagnetic interference.



During the wiring procedure, please separate the Strong current and light current lines to reduce the electromagnetic interference.



A surging absorber must be applied to the inductive load such as the AC contactor of the relay output.



Checking carefully for the wiring of the input/output before power applying.



Correctly grounding of the ground terminals of the unit (Third grounding) can improve the anti-noise capability of the unit.



The presetting of the rating current of the motor (skip current) is set to Rated Current on the name plate X Motor overload factor/1.2.

Features:

- **LCD Chinese/English display**
- **Full protection function for the motor in short circuit, locked rotor, phase lost, overload or unbalance.**
- **Start/Stop and operating control of the Motor**
- **Anti- reversing protection of Air Compressor**
- **Measuring and protection controlling to multi-points temperatures**
- **Automatic adjusting load rating to balance pressure**
- **High Integrity, Stable reliability and excellent value-ability**
- **Optional remote / machine side control**
- **Optional interactive/ independent operation**
- **RS-485 communication interface function**

I. Basic Operation

1. Buttons Description

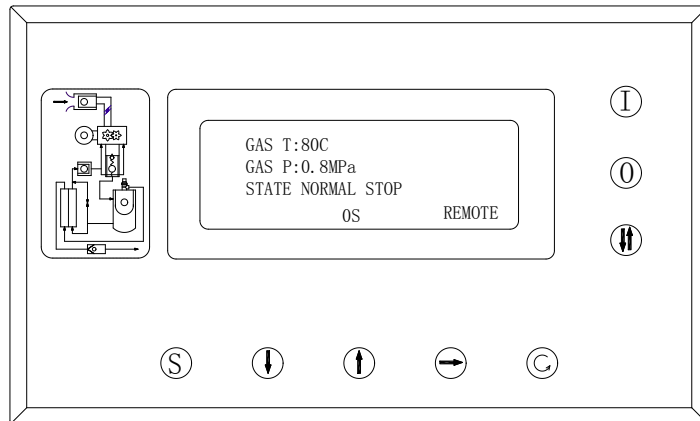

Figure 1

I——Start Button: Press this button to start the motor

O——Stop Button: Press this button to stop the motor

S——Set Button: Press this button to confirm the input data to be saved after modification of the data.

↑——Up button: Press this button to move upward during modification data. Press this button to select menu during the menu selection

↓——Down Button: Press this button to move downward during modification data. Press this button to select menu during the menu selection

→——Cursor / Confirm Button: This button can be used as cursor during the data modification and as confirm button during the menu selection

↓↑——Manual Loading/Releasing Button: In the manual Mode, press this button to loading or releasing under a certain pressure.

↶——Return/Preset Button: Press this button to return to upper menu during the menu operation. Press this button to reset the machine when the unit is stopped in failure.

2. Status Display and Operation

The display interface is as following when the units are POWERED ON:

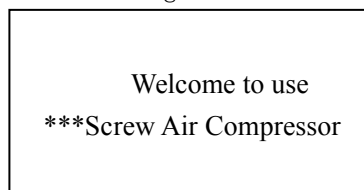

The main display after 5 seconds will be the following:

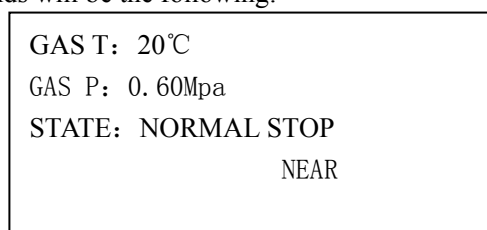

Press “↓” Enter the following Menu Selection Interface:

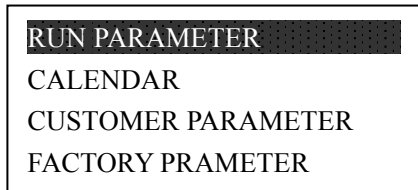

(见中英文对照表)

a. Run the Parameter Review

Press ‘↓’ or ‘↑’ to move the black cursor over the menu ‘RUN PARAMETER’ and then press ‘→’ to pop up the submenu:

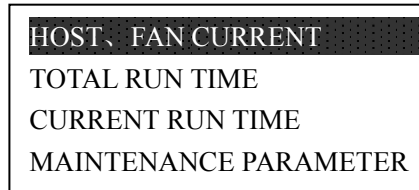

Press ‘→’ to pop up another menu:

CUR(A):	R	S	T
HOST:	56.1	56.2	56.0
FAN:	4.1	4.1	4.1

If the menu pop up is the last menu level, the black cursor will disappeared, press the RETURN button ‘↵’ and return to the upper menu or the main interface. If the operation is stopped in a certain interface, it will automatically return to the main interface after several seconds.

Using the moving buttons ‘↓’, ‘↑’, CONFIRM button ‘→’ return button ‘↵’ to view the RUN PARAMETERS such as the **RUN TIME**, **CURRENT RUN TIME** **MAINTENANCE PARAMETER**, **HISTORY FAILURE**, **PRODUCING DATE** and **CURRENT FAILURES** and then return to the upper menu with the similar method of the above.

b. Calendar and Time

Press ‘↓’ or ‘↑’ to move the black cursor to the menu ‘CALENDAR’ and then press ‘→’, the following menu will be pop up:

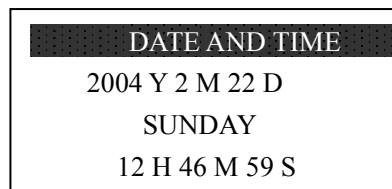

At the stop status of the unit, the date and time could be adjusted according to the following steps:

Press ‘↓’ or ‘↑’ to move the black cursor to the parameters you want to modify and then press ‘→’ to reach the blinking position. Now the button ‘↓’ and ‘↑’ are changed to ‘Pageup’ and ‘Pagedown’ button. Press ‘S’ button to confirm and save the data after finish the modification. The buttons ‘↓’ or ‘↑’ return to black cursor move button and the button ‘→’ change back to its Return function.

c. CUSTOMER PARAMETERS

1) Parameter Modification

—— The Customer Parameters and the Factory Preset Parameters can not be modified during the Running State and Stop Delaying period ——

The Customer Parameters could be read and modified with the same method of running the Parameter Review mentioned above. For example, to modify the parameter BLOCK UNLOAD PRESSURE, the steps will be as the following:

Press '↓' or '↑' to move the black cursor to 'CUSTOMER PARAMETER' menu and then press the CONFIRM button '→' to pop up the following menu:

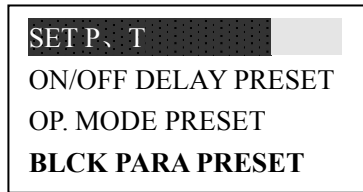

Press the CONFIRM button '→' again to reach the following menu:

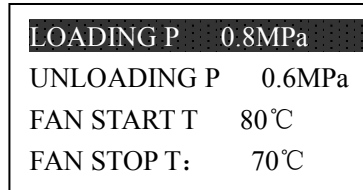

The CUSTOMER PARAMETERS can be read now when the CONFIRM button '→' is not pressed now. Press the CONFIRM button '→' again to pop up the following interface where the password input is needed:

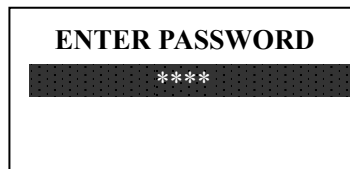

Attention: The Customer Password can me modified in the CUSTOMER PARAMETER, the DEFAULT PASSWORD is _____

The Blinking Position will appear after this interface displayed. The button '↓' and '↑' have been changed to PgUp and PgDwn button that could be used to change the current value. The button '→' is changed to move button to move the position where the modification is needed, Press 'S' to confirm and the following interface will be displayed:

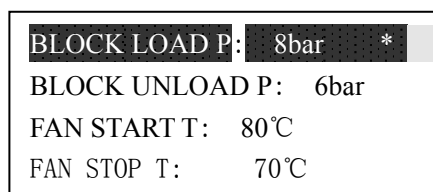

When there is a '*' displayed at the up right corner, it means it is at the CUSTOMER PARAMETER set status.

The '↓' or '↑' button return to black cursor and the button '→' return to be the CONFIRM button. Press the CONFIRM button '→' when the cursor is over the menu ' BLOCK UNLOAD PRESSURE', now the blinking position appears and the button '↓' and '↑' have been changed to PgUp and PgDwn button that could be used to change the current value. The button '→' is changed to move button to move the position where the modification is needed, Press 'S' to confirm and the blinking position will disappear. The '↓' or '↑' return to black cursor move button and the button '→' change back to its CONFIRM button to continue to modify the other CUSTOMER PARAMETERS. If there are no other parameters needed to be modified, press the button '↵' to return to the upper menu or the main menu. The other CUSTOMER PARAMETERS could be modified with the same method above.

2) The CUSTOMER PARAMETERS and its function

First Submenu	Second submenu	Preset Value	Functions
SET P. T.	UNLOAD P.	*.**Mpa	UNLOADING PRESSURE VALUE
	LOAD P.	*.**MPa	LOADING PRESSURE VALUE
	FAN START T.	***°C	Control the fan starting. This value will be set to '120°C' if there is no fan present or the fan is not required to be protected. ”
	FAN STOP T.	***°C	Control the stopping of the fan
ON/OFF DELAY TIME PRESET	HOST START TIME	0008s	When using the controller to protect the motor, it is required that the time here defined will not meet the impulse starting current of the motor, the value here must be longer than the STAR DELAY TIME plus LOAD DELAY TIME
	FAN START TIME	0006s	When using the controller to protect the motor, it is required that the time here defined will not meet the impulse starting current of the motor.
	STAR DELAY TIME	0006S	Star pressure release starting delay time.
	LOAD DELAY TIME	0002S	The loading delay time after star pressure releasing.
	EMPTY DELAY	0020M	Load free continuous running time, the machine will automatically stop after this time
	STOP DELAY TIME	0010S	The machine will not stop until this time passed the load free state when stop the machine
	START DELAY TIME	0100S	Machine can not be restarted before this set time after stopped or over time operation at load free state
	STANDBY DELAY TIME	0000S	Additional functions
	DRAIN OPEN TIME	0002S	The continuous draining time during the automatic draining control.
	DRAIN CLOSE TIME	0010M	The Draining Gap duration during the automatic Draining control
OPERATION MODE PRESET	ON/OFF MODE	Machine side	When the remote mode is set, both the buttons at machine side and the remote control button can turn on and off the machines
	LOAD MODE	Auto	When the manual mode is set, the Load/Unload function can only be executed by pressing buttons
	COM MODE	Prohibited	When this is set to 'PROHIBIT' the communication function is not available
	COM CODE	0255	Communication address

Continued

BLOCKING PARAMETERS PRESET	Blocking mode	HOST	Act as Host or Secondary Machine when there are more than one machines running in blocking mode. The HOST controls the SECONDARY
	BLOCKING ON/OFF	Sequence	
	Switching Time	9999 Hours	
	Block Number	0016	
	BLOCK LOAD P	*.**MPa	
	BLOCK UNLOAD P	*.**MPa	
	BLOCK DELAY TIME	0000S	
Maintenance Parameter Preset	O/ F RESET	0000 HOURS	Reset time for the duration of oil filter changing
	O/G RESET	0000Hours	Reset time for O/G Separator changing
	G/F FILTER RESET	0000Hours	Reset time for gas filter changing
	LUB OIL RESET	0000Hours	Reset time for Lubricate Oil Changing
	LUB GREASE RESET	0000Hours	Reset time for Lubricate Grease Changing
MAX LIFE TIME PRESET	OIL FILTER	9999Hours	Set this value to '0' will make the oil filter alarm not available
	O/G SEPARATOR	9999Hours	Set this value to '0' to disable the O/G separator alarm function
	GAS FILTER	9999Hours	Set this value to '0' to disable the alarm function of gas filter
	LUB. OIL	9999Hours	Set this value to '0' to disable the time alarm of lub. oil
	LUB GREASE	9999Hours	Set this value to '0' to disable the time alarm of Lub. Grease
Language Select(Chinese/English)		Chinese	Set to 'ENGLISH' will change the interface to be English display.
NEW USER PASSWORD		****	Customer could modify the user password

d) DEFAULT PARAMETERS

The difference of the DEFAULT PARAMETERS and the CUSTOMER PARAMETERS is that the DEFAULT PARAMETERS can not be modified unless you have the initial password from the factory. The modification method of the DEFAULT PARAMETER is the same as that of the CUSTOMER PARAMETER. The main functions of the parameters are as the following table..

PARAMETER	Initial Value	Functions
HOST RATED CURR.	MAXIMUM OVERLOAD VAULE OF THE MOTOR /1. 2	After the starting delay time, when the motor current is greater than 1.2 times of the set value and less than 4 times of the set value, the unit will jump as per overload feature.
FAN RATED CURR.	Maximum allowable motor overload value/1.2	Same as above
PRE-ALARM T	105°C	Alarm when the temperature reaches this set value
STOP T.	110°C	Alarm when the air exhausting temperature reaches this set value.
STOP P.	1.00MPa	Alarm and stop machine when the air supply temperature reaches this set value
UNLOAD LIM P	0.80MPa	The Unload Limit Pressure in the Customer Parameter must be set lower than this value.
MODI LOAD TIME	****Hours	The factory can modify the load running time

MODI TOTAL TIME	****Hours	The factory can modify the total running time
HISTORY FAULT RESET	****	Input the history failure password to clear al the history failures.
UNBALANCE SCOPE	0006	When (the max. phase current/min. phase current) is not greater than (1+set value), the unbalance protection will stop the machine. If the set value is greater than 15, the unbalance protection will be disabled.
LACK PHASE STOP	0005	Set the LACK PHASE TIME $\geq 20S$, the Lack phase protection will be disabled, if the unbalance protection is active, it will be started.
OVERLAOD RESTART DELAY	0000 M	If the motor is stopped when overloaded, in order to avoid frequency starting of the motor, the motor can only be restarted after this delay time whether it is the power down or reset.
PROD. DATE	****Y**M**D	The factory input the product date of the unit.
PROD. NO.	*****	The factory input the product No. of the unit

II. Functions and Technical Parameters

1. Switching value: 9 ways of Switching value input; 10 ways of relay switching value input.
2. Analog quantity: 2 Pt100 temperature input; 2 ways of 4~20mA transferred input; 2 groups of 3 phase current input (Match with CT)
3. Input voltage of phase sequence: 3 phase 380V.
4. Working Power of the controller: 220V, 50Hz, 20VA.
5. Display measuring Range
 - a) Oil Temperature of Oil: $-20\sim 150^{\circ}C$; Accuracy: $\pm 1^{\circ}C$.
 - b) Air Temperature: $-20\sim 150^{\circ}C$ Accuracy: $\pm 1^{\circ}C$.
 - c) Running Time: 0~999999Hours.
 - d) Current Display Measuring Range: 0~999.9A.
 - e) Pressure: 0~1.60Mpa, Accuracy: 0.01Mpa.
6. Phase sequence Protection: When the wrong phase is detected by the protector, it activate for the time $\leq 2s$.
7. Motor Protection: This control unit has the following 5 basic protection functions to the motor and fan.
 - ① Rotor Lock protection: After the starting of the motor, if the working current reaches 4 or 8 times of the set value, the protection activates. The activate time is less than 0.2s.
 - ② Short-Circuit Protection: if the detected current reaches 8 times or more above the set value, the protection activates, the activate time is less than 0.2s.
 - ③ Lack phase protection: Any of the phase lack, the protection activates and the activate time is less than 2s.
 - ④ Unbalance Protection: the current difference between any of the two phases reaches the percentage of 60~75%, the protection activates and the activate time is less than 5s.
 - ⑤ Overload anti-time limitation protection (time unit: s): See the following table. The multiple= I_{act}/I_{set} actual value / I Set Value.

When the running current of the motor is not less than 1.2 ~3.0 times of the set value, the overload multiple and action delay time will be accordance with the following table.

I_{act}/I_{set} Time Para	≥ 1.2	≥ 1.3	≥ 1.5	≥ 1.6	≥ 2.0	≥ 3.0
Action time	60	48	24	8	5	1

Table 2: Motor anti-time limitation protection Table

- 8 Temperature Protection: When the actual detected temperature is higher than the set temperature, the protection activates and the activate time $\leq 2s$.
- 9 The output relay contactor capacity:250V5A. The life time of the contactors: 500000 times of running.
- 10 The current display tolerance $<1.0\%$.
- 11 RS—485 communication.

III. Specification

1. Specification Description

MAM—KY02S (40) (B) (T) —VIII

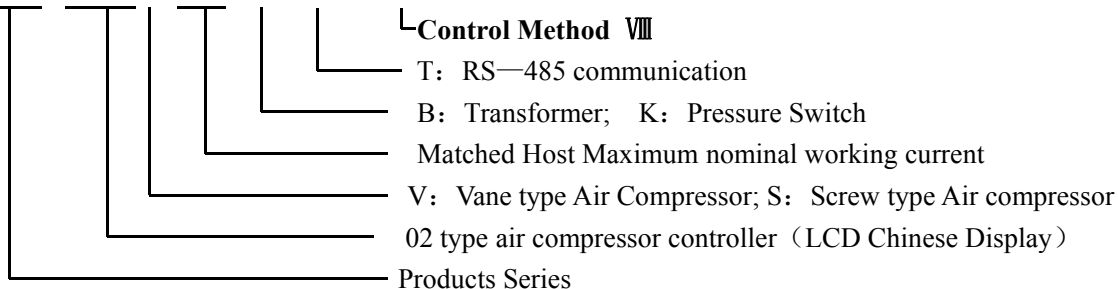

2. Adopted motor Power Specification

Parameter Spec.	Current Range (A)	Adopted Host Motor Power (KW)	Remarks	Descriptions
MAM—KY02S (20)	8~20	4~10		Fan Current with the band of 2~2.5A;1~5A and 4~10A defined by the fan motor current.
MAM—KY02S (40)	16~40	8~20		
MAM—KY02S (100)	30~100	15~50		
MAM—KY02S (200)	80~200	40~100		
MAM—KY02S (400)	160~400	80~200		
MAM—KY02S (600/5)	100~600	50~600	Connect to CT	

IV. Measurement and Installation

1. Mechanical Installation

A. Mutual Inductor Installation

The installation of the mutual Inductor should be located at the places accessible for measuring the motor line current (rated current) so that the setting of the controller could be according to the nameplate of the motor. The recommended installation sizes are as below:

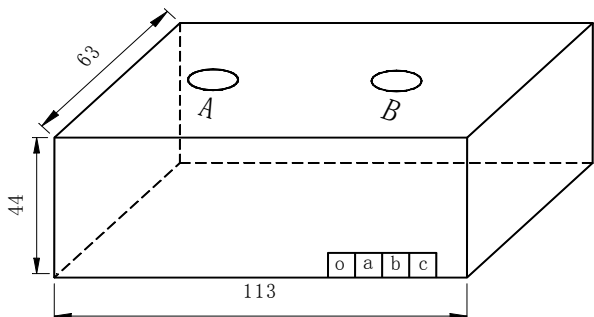

Diagram 2. CT1 Structure Size ($\phi 36$ through hole)

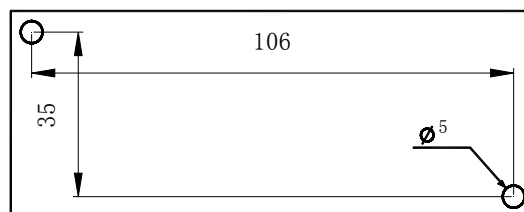

Diagram 3: CT1 Installation Size

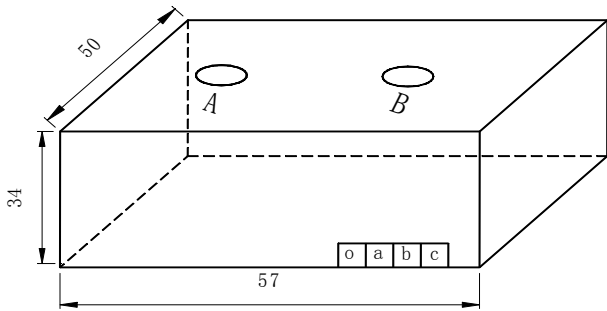

Diagram 4: CT2 Structure Size (ϕ 10 through hole)

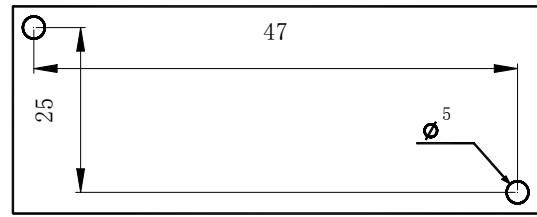

Diagram 5: CT2 Installation Size

B. The installation of the controller

The Controller will be installed in the control cabinet. There must be enough spaces around the controller for the accessibility when making the wiring. The recommended sizes are as below:

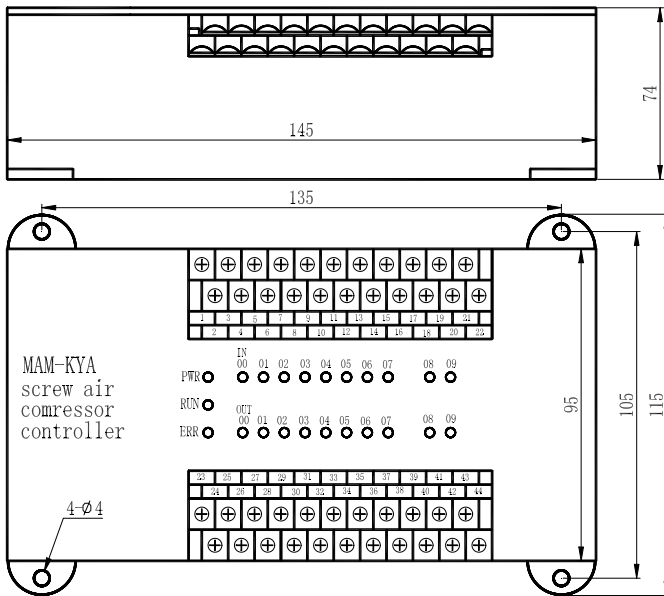

Diagram 6: Main Control Unit Structure Size

1. Input LCD (IN):

00, 01, 02, 03, 04, 05, 06 and 07 is relatively correspond to the input switching value terminals of 20, 19, 18, 17, 16, 15, 14 and 13.

2. Output LCD (OUT)

00, 01, 02, 03, 04, 05, 06, 07, 08 and 09 is relatively corresponded to the output switching value terminals of 27, 28, 29, 30, 31, 35, 36, 37, 38 and 39.

3. Power LCD: PWR 灯

4. Running LCD: RUN LCD

5. FAILURE LCD: ERR LCD

C. The function of the display panel and installation

200 Type display panel is installed on the front panel of the control cabinet.

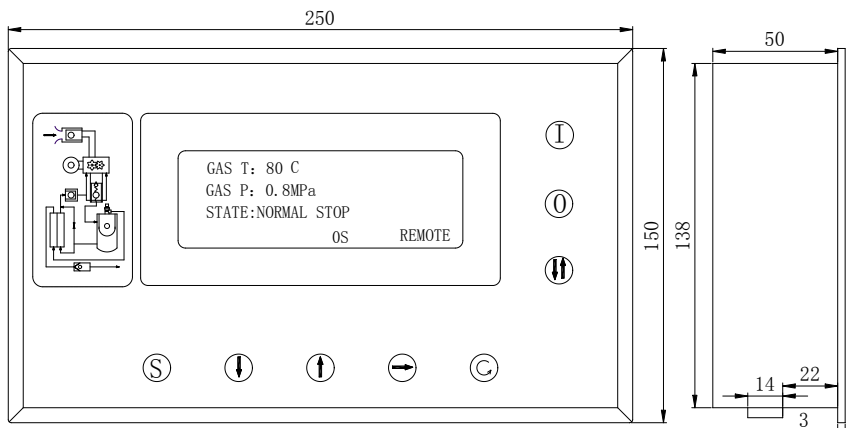

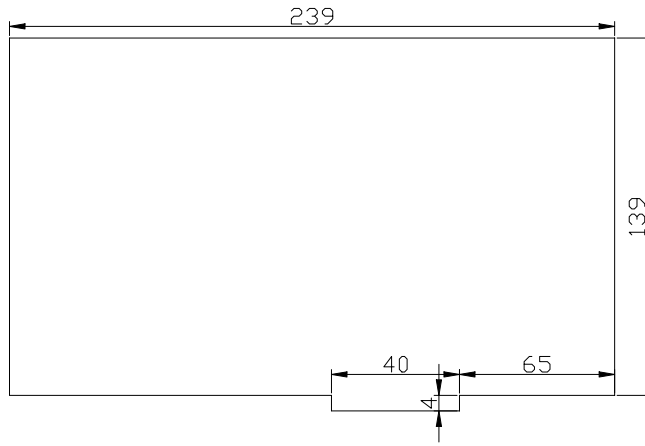

Diagram 6. The size of the board and the holes dimensions

2. The Basic Wiring diagram of the electronic Installation.

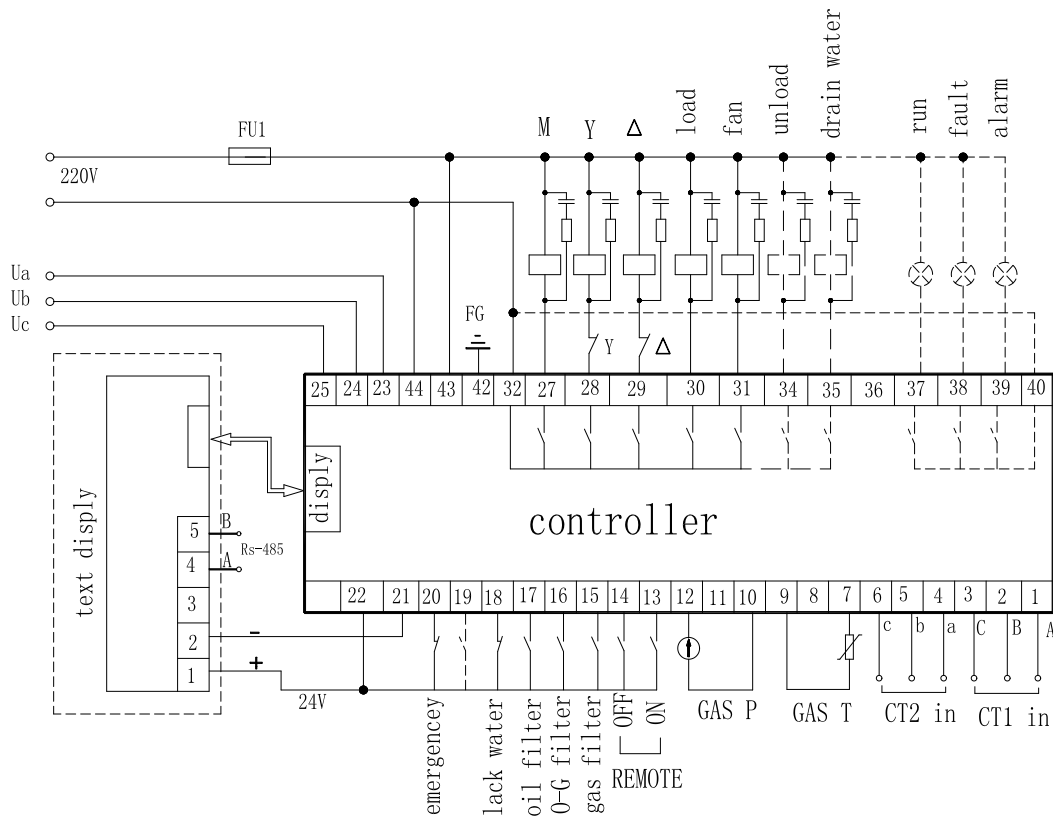

Diagram 8. The array of the connector terminals

Text Display connector terminals:

There are five connect terminals and one D type display cabal connector which are relatively used for the display connector, Rs—485 communication interface and 24V Power input

Controller Connect Terminals:

The display panel is connected with the controller using communication cabals. 23, 24 and 25 are the phase sequence input terminals; 7 and 9 are the Air Exhaust Temperature Input terminals; CT1 is the host mutual inductor; CT2 is the fan mutual Inductor. 32 is the common port COM1 of the relay output; 27 controls the main contactor; 28 controls the star contactor; 29 controls the angel contactor; 30 is the loading magnetic valve; 31 controls the Fan; 34 controls the Load release valve: 37 is the running indicator; 38 is the Failure indicator; 39 is the Alarm indicator; 40 is COM2; 42 is the simulated ground (Earth); 43 and 44 are the 220V power source.

Attention: the magnetic coil must be connected to the surging absorber when wiring

V. Control Principle (Refer to the attached for the Electric schematic circuit)

(A) Individual Control

(1) Local Automatic control(ON/OFF mode: Beside Machine; Loading method: Automatic)

① Press 'I' to start: (Y—△ Starting)

When the controller is powered on, it will perform a 3S self-checking. Press the 'I' button cannot start the machine until the self-checking is completed. The starting process of the host will be as the following: KM3 is powered on, KM2 is Powered on → Y type Starting Status → Time Delay finish (Y—△ converting time) , KM3 loss power (KM1 and KM3 interlocked), KM1 is powered on → Motor runs in △ type and the Starting is completed. All the magnetic Valves are without power during the whole starting process to ensure the load free starting.

② Automatic Running Control:

When the motor is started to running in △ status and load the magnetic valve with power applied after a certain period of delay. Then the air compressor will be applied with air pressure to increase the pressure in the air tank. When the air pressure reaches the value over the set unload pressure (unload pressure value), the loading magnetic valve will loss power and the release magnetic valve is applied with power to run the air compressor with load free. If in the specified time (load free running period) the air pressure turns to be lower than the set load pressure (LOAD PRESSURE VALUE), the load magnetic valve obtains power and the unload magnetic valve losses power, the air compressor will apply normal pressure to increase the pressure in the air tank. If the pressure in the air tank is not drop down to the load pressure limit within the load free running time, the controller will automatically stop the running of the motor to perform the automatic stop of machine for over time load free running. Only when the pressure drops to the load pressure limit, the motor could restart according to the normal starting process and it runs repeat in this way.

③ Manual Load/unload at the automatic status

At the automatic status, the unit will stay in the unload state, press the button '↓↑' to load, if the pressure is higher than the unload pressure, the load magnetic valve will inch once and then return to the unload status; if the pressure is lower than the unload pressure, the load magnetic valve will be applied with power and will not stop running and return to the unload state until the air supply pressure becomes higher than the unload pressure. When the unit is at the load state, press the button '↓↑' to unload. If the pressure is higher than the load pressure, the load magnetic valve will loss the power and return to the load state till the air supply pressure becomes lower than the load pressure. If the pressure is lower than the load pressure, the unload function is disable.

④ Normal Stopping:

Press the button 'O', the load magnetic valve will loss power and the unload magnetic will be applied with power, after a while of delay (stop delay), the motor contactor will loss power, the host and fan will stop running, after the restarting delay completed, the unload magnetic will loss power. Only pressing the button 'I' could restart the motor.

⑤ Frequency starting prevent control

The motor can not be started immediately unless after a while of time delay after stopped by pressing 'O' button or stopped due to failure. Whenever the situation is, this controller will display the remaining count down of the time delaying (such as 90s). The motor can only be started when the time display is 0.

(2) Remote Automatic Control (ON/OFF mode: Remote; Load mode: Automatic)

The remote automatic control is almost the same as the local automatic control, the only difference is that the start and stop of the unit is controlled by remote control.

(3) Local Manual Control (On/Off mode: beside machine; Load mode: Manual)

The Starting and stopping control is the same as the automatic control, the only difference is that when the starting procedure finished in this mode, the machine is at the load free state and will be loaded by pressing the button '↓↑'. When the air supply pressure is higher than the unload pressure, the unit will load automatically, if the button '↓↑' is not pressed to load, the unit will be running at the load free state till load free stop. During the unload process, press the button '↓↑' to load and during the process of loading, press the button '↓↑' to unload

(4) Remote Manual Control (On/Off Mode: Remote; Load mode: Manual)

The remote automatic control is almost the same as the local manual control, the only difference is that the start and stop of the unit is controlled by remote control.

(B) Network control

(1) When the control network is set to 'COMPUTER', it could perform the computer network control of the units

(2) Set the controller communication to 'BLOCKING' could perform the network control between the controllers but the host must be 1# controller.

(C) Fan Temperature control

When the air Exhausting temperature is higher than the fan starting temperature, the Fan motor will run; when the air exhausting temperature is lower than the fan stop temperature, the fan motor will stop running. If there is no fan or the fan is not necessary to be protected, set the starting temperature of the fan to '120℃' and the stop temperature to be '70℃'.

(D) Failure stop and Emergency stop

When there is any electronic failure or high air temperature failures occurred during the running process, the controller would stop the motor immediately. The motor can only be restarted after the failures are cleared. Any emergency situation occurred, please press down the emergency stop button to cut off the power supply of the controller and contactor power.

VI. Alarm and Notices

(1) Text Display tips

① Air filter Alarm tips

a. Check the alarm using the switch signal

The controller can display the message on the text display to remind the operator that 'the air filter is blocked' by checking the pressure difference switch operating state.

b. Set the running time alarm of the air filter

The Text displays 'Air filter life terminated' when the using time of the air filter terminates.

② Oil Filter alarm tips

a. Check the alarm using the switch signal

The controller can display the message on the text display to remind the operator that 'the oil filter is blocked' by checking the pressure difference switch operating state.

b. Set the running time alarm of the oil filter

The Text displays 'Oil filter life terminated' when the using time of the oil filter terminates.

③ Oil separator alarm tips

a. Check the alarm using the switch signal

The controller can display the message on the text display to remind the operator that 'the oil separator is blocked' by checking the pressure difference switch operating state.

b. Set the running time alarm of the oil separator

The Text displays 'Oil separator life terminated' when the using time of the oil separator terminates.

④ Lubricate Oil alarm tips

The Text displays ‘Lubricate Oil life terminated’ when the using time of the lubricate oil terminates.

⑤ Lubricate Grease alarm tips

The Text displays ‘Lubricate Grease life terminated’ when the using time of the lubricate grease terminates.

(2) Main Controller Tips

Item	Meaning and Functions	Lights Status
POWER	Controller Power on	PWR Lights
RUN	Controller run	RUN Lights
Failure	Detect failure and Stop the unit	ERR Blinking
Input Switching Value	Terminal 20~12 Input switching value activate	IN00~08 lights, but if there is no function at the input point, no light lighting
Output Switching Value	Terminals 27,28,29,30,31,35,36,37,38 and 39 output switching value activate	OUT00~09 lights
Data Save	Set Data and save time	PWR blinking once

VI. SAFETY PROTECTION

① Motor Protection

MAM—KY02S air compressor controller can perform the short-circuit protection, rotor lock protection, overload protection, Phase Lacking Protection and Unbalance Protections to the motor.

Electronic failure	Failure Display	Possible Causes
Short-Circuit	Local Failure display ‘Host or Fan short-circuited’	Short-circuited or the rated current is wrongly set
Rotor lock	Local Failure display ‘Host or Fan Rotor Locked’	Overloaded, Bearing wear off or other mechanic Failures
OVERLOAD	Local Failure display ‘Host or Fan Overloaded’	Overloaded, Bearing wear off or other mechanic Failures
Phase Lack	Local Failure display ‘ Host or Fan Phase Lacking’	Phase lacking occurred to the Power or the connectors
Unbalance	Local Failure display ‘ Host or Fan current unbalance’.	Contactors are not contacted correctly or the motor inner parts open.

② Air Exhaust overheat protection

When the air exhaust temperature is higher than the set limited unload temperature, the controller will alarm and stop the machine. Local Failure display ‘Air Exhaust High Temperature’.

③ Reverse running protection of the air compressor

When the phase sequence of the power connected to the air compressor is not conform to the set of the controller, the local failure displays ‘ Wrong phase sequence’ and as a result the controller can not start the motor. It is needed to check and alternate any two of the phase sequence and investigate the motor rotation direction.

④ Over Pressure protection

When the pressure of the air exhaust is higher than the set unload pressure of the controller, the controller will

alarm and stop the machine, the local failure displays 'Pressure too high'.

⑤ Sensor Failure Protection

When the cable of the pressure sensor or the temperature sensor is broken, the controller will alarm and stop the machine and the local failure displays '** sensor failure'.

⑥ Interlock Protection

The Host is running and the air exhaust temperature reaches the Fan starting temperature but the Fan does not run, the controller alarm, the local failure displays ' Fan is stopped'

VIII. Common Failure Solving

The failures caused by the peripheral equipments of the controller could be investigated by queering from the local failure record or the history failure record to find out the failure causes and solves the relative problem. The detailed method is as the following:

Press the button '↓' or '↑' to move the black cursor over the menu ' Run Parameter' and then press the confirm button '→' to popup the submenu as the following:

MOTORS CURRENT
TOTAL RUN TIME:
CURRENT RUN TIME
MAINTENANCE

Press the button '↓' repeat to popup the following menu:

HISTORY FAULT
PROD. DATE/NUM
CURRENT FAULT

Press '→' to reach the following failure cause:

Temperature sensor Failure
170°C

Check the Temperature sensor to confirm if there are any line broken or damage of this equipment.

COMMON FAILURE AND THE CAUSES:

FAILURE	CAUSES	MEASUREMENT TO TAKE
Air Exhaust Temperature too high	Bad vent condition, Oil lacking etc.	Check the vent condition and lubricant amount etc.
Temperature Sensor Failure	Cable off or PT100 damaged	Checking the wiring and PT100
Over Pressure	The pressure too high or the pressure sensor failure	Check the pressure and the pressure sensor
Pressure Sensor Failure	Cable off, Sensor damaged or the cable connected reversed	Check the wiring and sensor transformer
Water Lacking	Water Pressure switch damaged	Check the water pressure switch
Phase Lacking	Power phase lacking or the Contactor terminal damaged	Check the power and contactors
Overloaded	Voltage too low, tubes blocked, Bearing Wear off or other mechanical failure or wrong set data etc.	Check the set data, Voltage, bearings, tubes and other mechanical system.
Unbalance	Power unbalance, Contactor damaged or the internal open of the motor	Check the power, contactors and the motor
Rotor Lock	Voltage too low, tubes blocked, Bearing Wear off or other mechanical failure or wrong set data etc.	Check the set data, Voltage, bearings, tubes and other mechanical system.
Short Circuit	Wrong Wiring, Incorrect Data setting etc.	Checking the wiring and set the data correctly
Wrong Phase Sequence	Reversed Phase sequence or phase off	Check the wiring
Fan stopped	Fan damaged, Contactor damaged, no control output	Check the wiring and control output
Overload or Rotor locking during starting process	Host start time set to a valueless than the star angel time delay	Reset the host starting time to be longer than star angel delay + Load delay time
Main Contactor activate time to time	The emergency button loose	Check the wiring